

- Ⓓ Befolgen Sie stets die Anleitung des Herstellers!
- ⒸⒺ Please generally follow the manufacturer's instructions!
- ⒻⒼ Suivez toujours les instructions du fabricant!
- ⒼⒹ Volg steeds de handleiding van de producent!
- ⒺⒶ Siga siempre las instrucciones del fabricante!
- ⒶⒻ Stale przestrzegaj instrukcji producenta!

- ⒹⒶ Всегда следуйте инструкции производителя!
- ⒻⒼ Seguire sempre le istruzioni del produttore!
- ⒼⒹ Mindig tartsa be a gyártó utasításait!
- ⒶⒻ Siga sempre as instruções do fabricante!
- ⒶⒻ Vždy dodržujte pokyny výrobce!

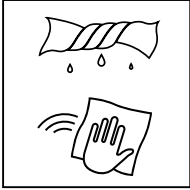

- Ⓓ Verwenden Sie zur Reinigung nur ein feuchtes Tuch!
- ⒸⒺ Please only clean with a damp cloth!
- ⒻⒼ N'utilisez qu'un chiffon humide pour le nettoyage!
- ⒼⒹ Gebruik voor de reiniging enkel een vochtige doek!
- ⒺⒶ Para limpiar utilice sólo un paño húmedo!
- ⒶⒻ Do czyszczenia używaj wilgotnej szmatki!

- ⒹⒶ Для очистки используйте только влажную ткань!
- ⒻⒼ Per la pulizia, utilizzare solo un panno umido!
- ⒼⒹ A tisztításhoz elegendő egy nedves kendő használata!
- ⒶⒻ Para a limpeza use apenas um pano húmido!
- ⒶⒻ Pro čištění používejte pouze vlhký hadřík!

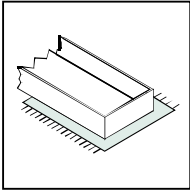

- Ⓓ Bauen Sie das Produkt auf einer Unterlage auf!
- ⒸⒺ Please mount the product on a bottom support!
- ⒻⒼ Montez le produit sur une base!
- ⒼⒹ Monteer het product op een basis!
- ⒺⒶ Monte el producto sobre una base!
- ⒶⒻ Rozkládaj produkt na podkładce!

- ⒹⒶ Собирайте изделие на подстилке!
- ⒻⒼ Montare il prodotto su un supporto!
- ⒼⒹ Az összeszereléskor helyezzen a termék alá megfelelő alátétet!
- ⒶⒻ Monte o produto numa superfície plana!
- ⒶⒻ Výrobek smontujte na pevném podkladu!

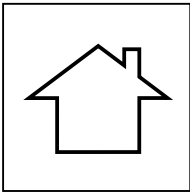

- Ⓓ Verwenden Sie das Produkt nur in Innenräumen!
- ⒸⒺ Please exclusively use the product indoors!
- ⒻⒼ N'utilisez le produit qu'à l'intérieur!
- ⒼⒹ Gebruik het product enkel binnenshuis!
- ⒺⒶ Utilice el producto sólo en interiores!
- ⒶⒻ Używaj produkt tylko w pomieszczeniach wewnętrznych!

- ⒹⒶ Используйте изделие только во внутренних помещениях!
- ⒻⒼ Utilizzare il prodotto solo in ambienti interni!
- ⒼⒹ A termék csak bel terekben használható!
- ⒶⒻ Use o produto apenas no interior!
- ⒶⒻ Používejte výrobek pouze uvnitř!

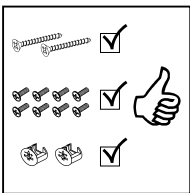

- Ⓓ Legen Sie die Beschläge zusammen und prüfen Sie die Vollständigkeit!
- ⒸⒺ Please join the fittings and verify their completeness!
- ⒻⒼ Pliez les raccords ensemble et vérifiez qu'ils sont complets!
- ⒼⒹ Leg de onderdelen samen en controleer de volledigheid!
- ⒺⒶ Junte los accesorios y compruebe que están todos!
- ⒶⒻ Rozlož poszczególnie części i sprawdź kompletność!

- ⒹⒶ Положите фурнитуру в одно место и проверьте комплектность!
- ⒻⒼ Mettere insieme le guarnizioni e verificare la completezza!
- ⒼⒹ Állítsa össze a sarokvasakat, és ellenőrizze, hogy épek-e!
- ⒶⒻ Coloque os encaixes juntos e verifique se estão completos!
- ⒶⒻ Složte armatury a zkontrolujte úplnost!

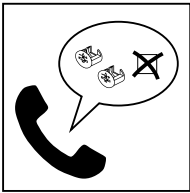

- Ⓓ Bei fehlenden Teilen kontaktieren Sie den Hersteller!
- ⒸⒺ If parts are missing, please turn to the manufacturer!
- ⒻⒼ En cas de pièces manquantes, veuillez contacter le fabricant!
- ⒼⒹ Contacteer de fabrikant als er onderdelen ontbreken!
- ⒺⒶ En el caso de que falten piezas, póngase en contacto con el fabricante!
- ⒶⒻ W razie braku części skontaktuj się z producentem!

- ⒹⒶ При отсутствии каких-либо частей обратитесь к производителю!
- ⒻⒼ In caso di pezzi mancanti, contattare il produttore!
- ⒼⒹ Ha hiányozna valamely k elem, lépjen kapcsolatba a gyártóval!
- ⒶⒻ Em caso de peças em falta, entre em contato com o fabricante!
- ⒶⒻ Pro chybějící díly kontaktujte prodejce!

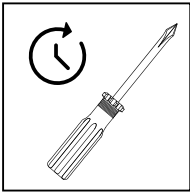

- Ⓓ Ziehen Sie die Schrauben nach einiger Zeit des Gebrauchs erneut fest!
- ⒸⒺ Please re-tighten the screws after having used the product for a while!
- ⒻⒼ Resserrer les vis après un certain temps d'utilisation!
- ⒼⒹ Draai de schroeven na een zekere gebruikstijd opnieuw vast!
- ⒺⒶ Asegure de nuevo los tornillos tras usarlo durante un tiempo!
- ⒶⒻ Po pewnym czasie użytkowania ponownie dokręć śruby!

- ⒹⒶ Спустя некоторое время использования подкрутите гайки!
- ⒻⒼ Stringere nuovamente le viti dopo un certo periodo di utilizzo!
- ⒼⒹ A használat során némi idő elteltével húzza meg újra a csavarokat!
- ⒶⒻ Reaperte os parafusos após algum tempo de uso!
- ⒶⒻ Po určité době používání šrouby znovu utáhněte!

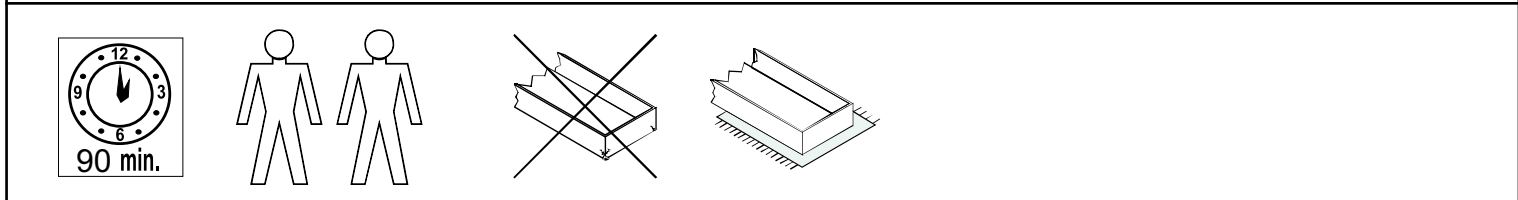

rozměry v mm				
①	1×	1800	350	18
②	1×	1800	350	18
③	1×	264	332	18
④	1×	264	332	18
⑤	1×	264	300	18
⑥	1×	264	300	18
⑦	1×	450	260	18
⑧	1×	450	260	18
⑨	1×	776	260	18
⑩	1×	1695	275	3

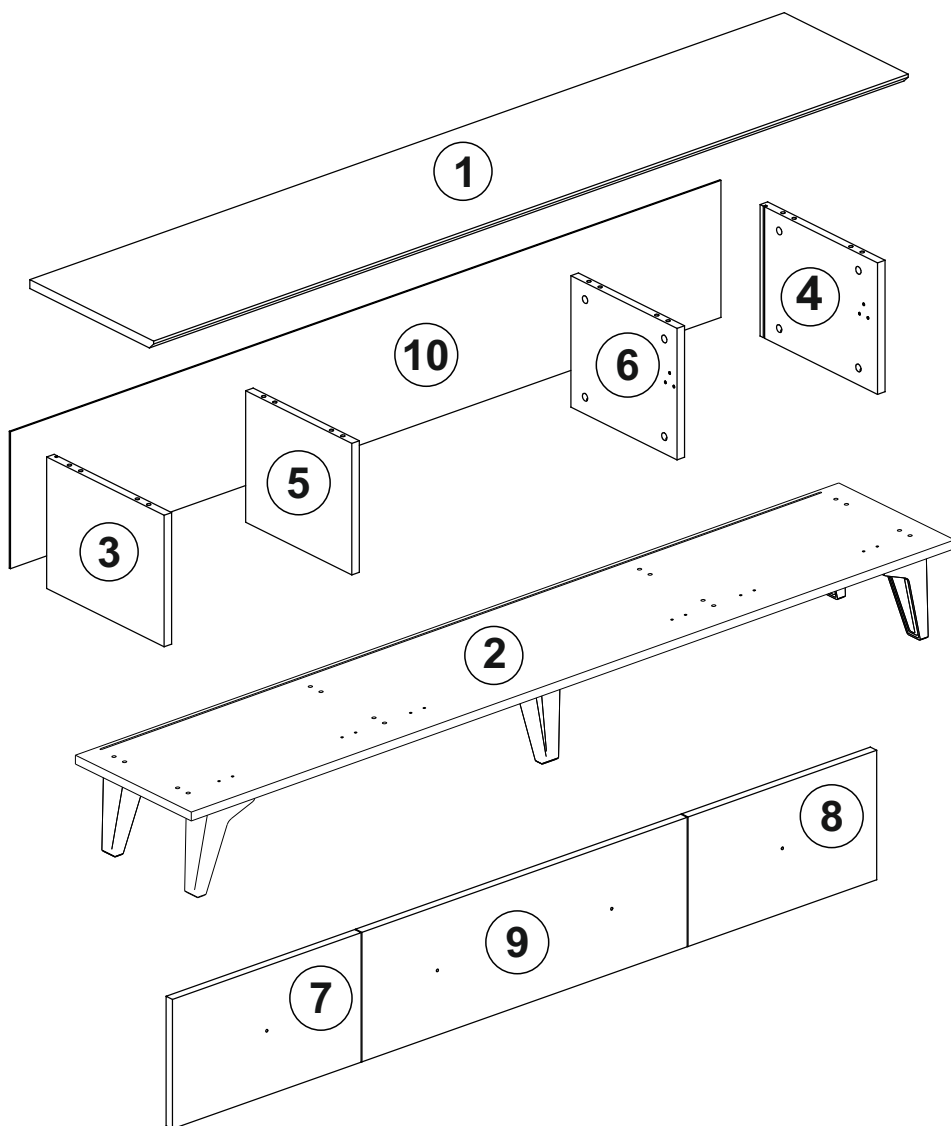

karton 1	1× 1; 1× 2; 1× 3; 1× 4; 1× 5; 1× 6; 1× 7; 1× 8; 1× 9; 1× 10
-----------------	---



karton 1

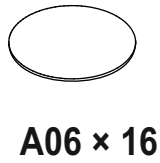
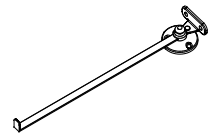
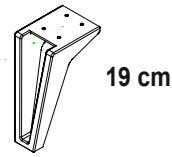
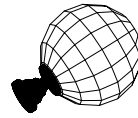
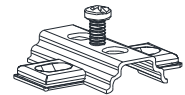
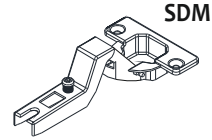
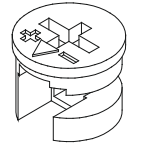
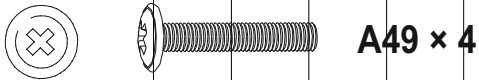
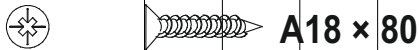
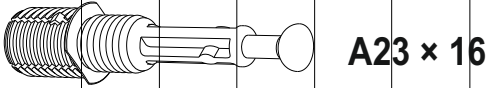

1

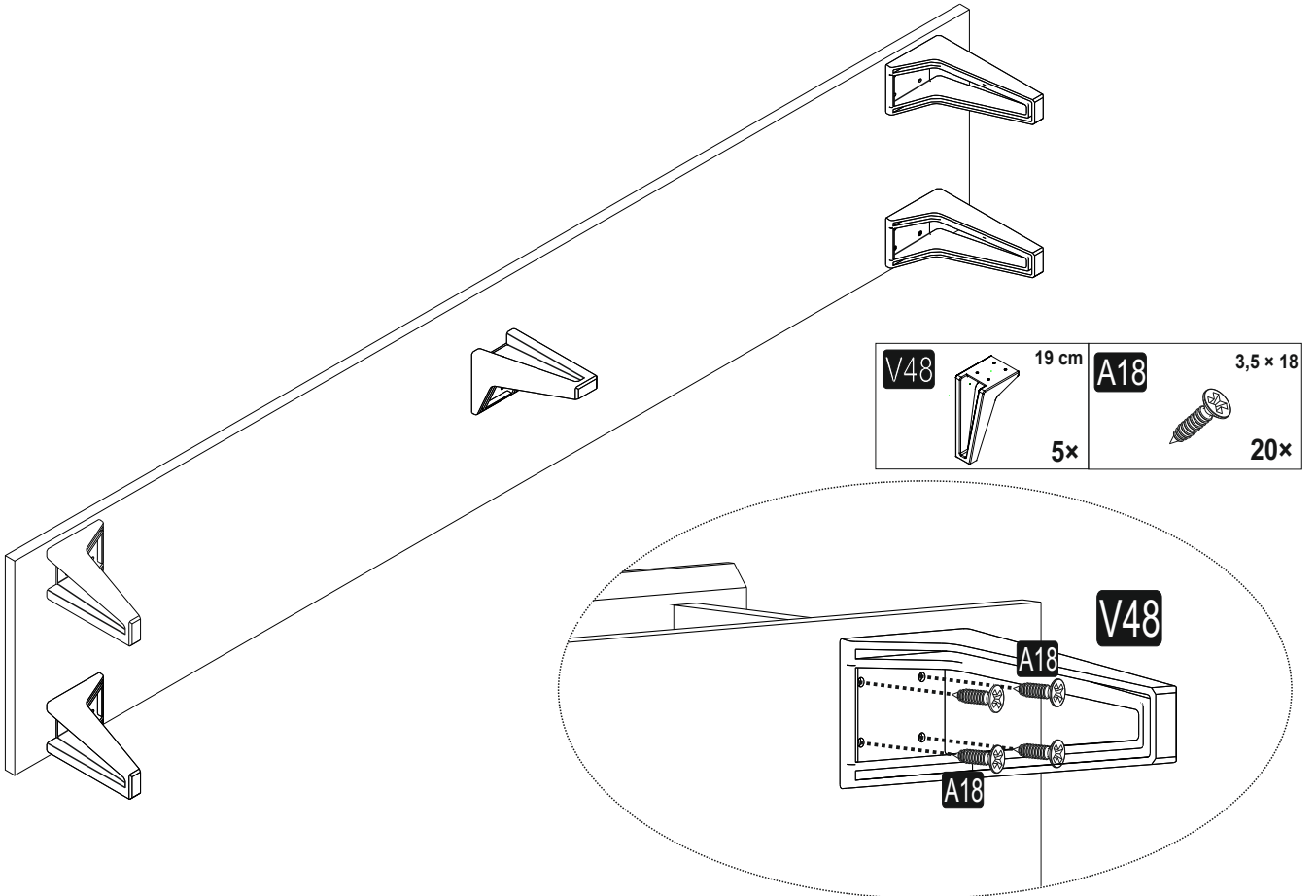

2

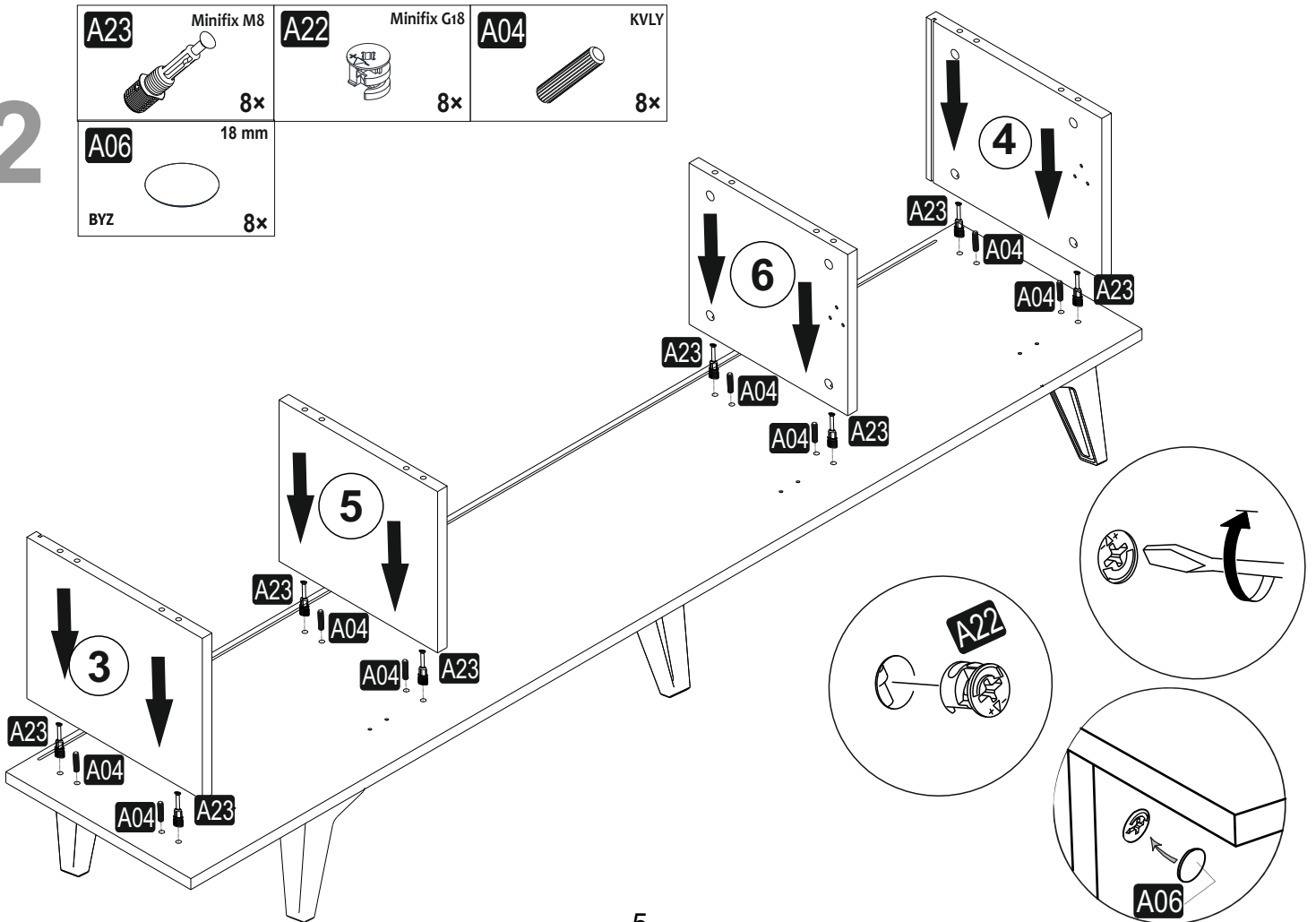

3

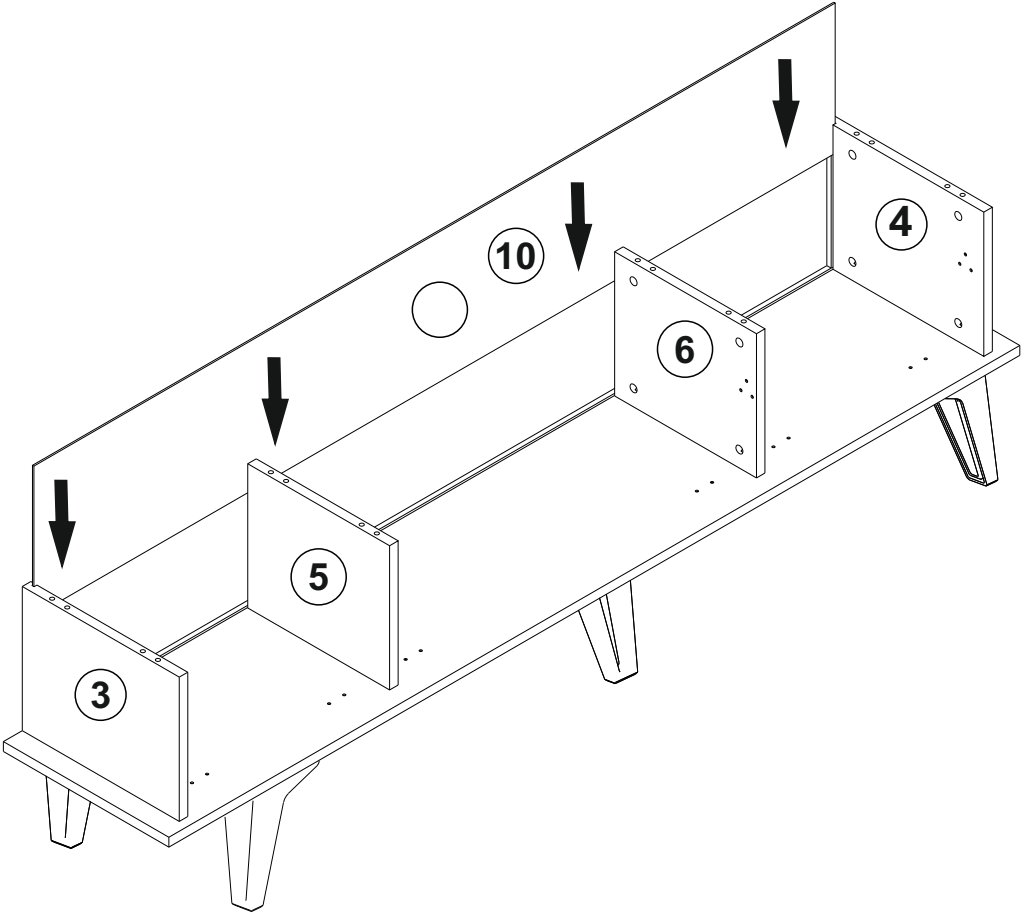

4

A23 Minifix M8 8x	A22 Minifix G18 8x	A04 KVLV 8x
A06 18 mm BYZ 8x		

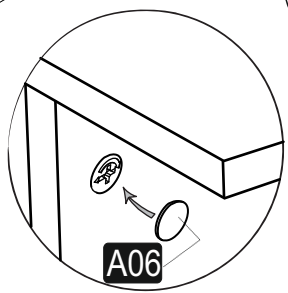
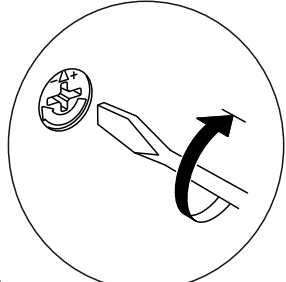
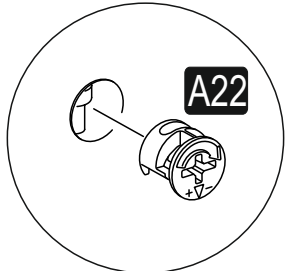
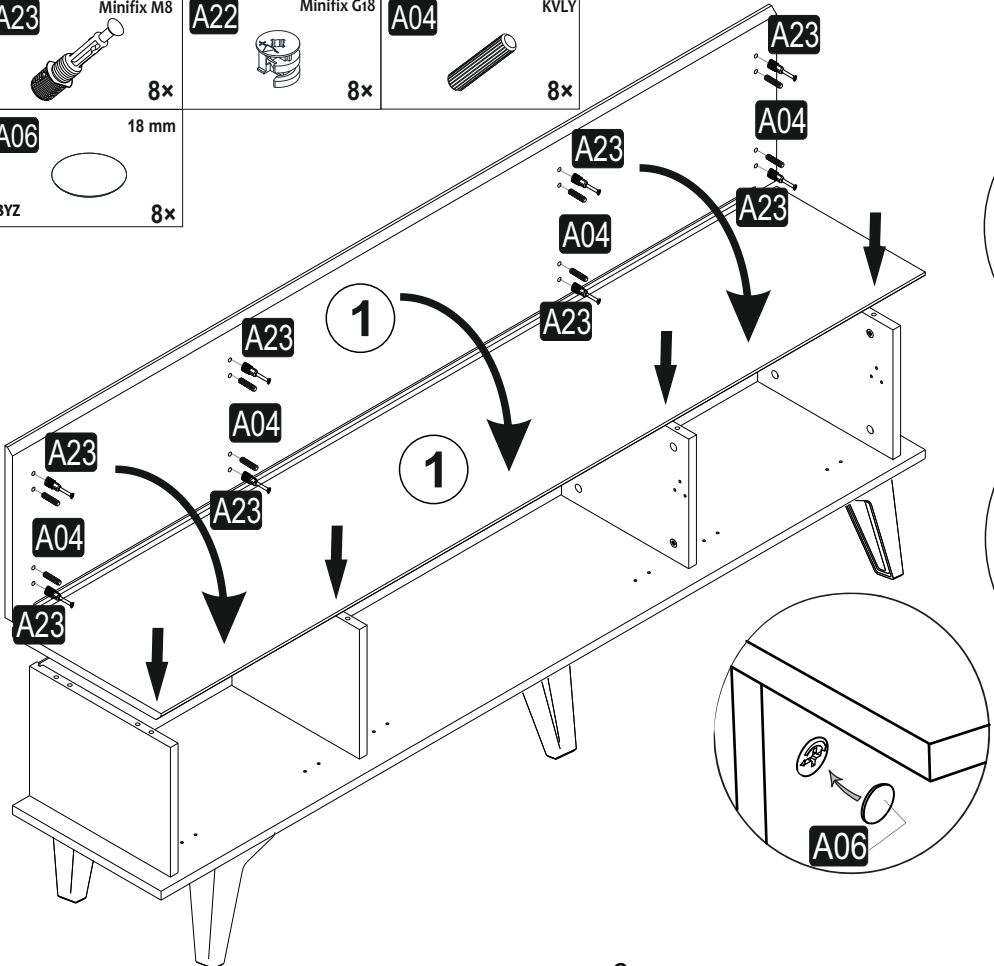

7

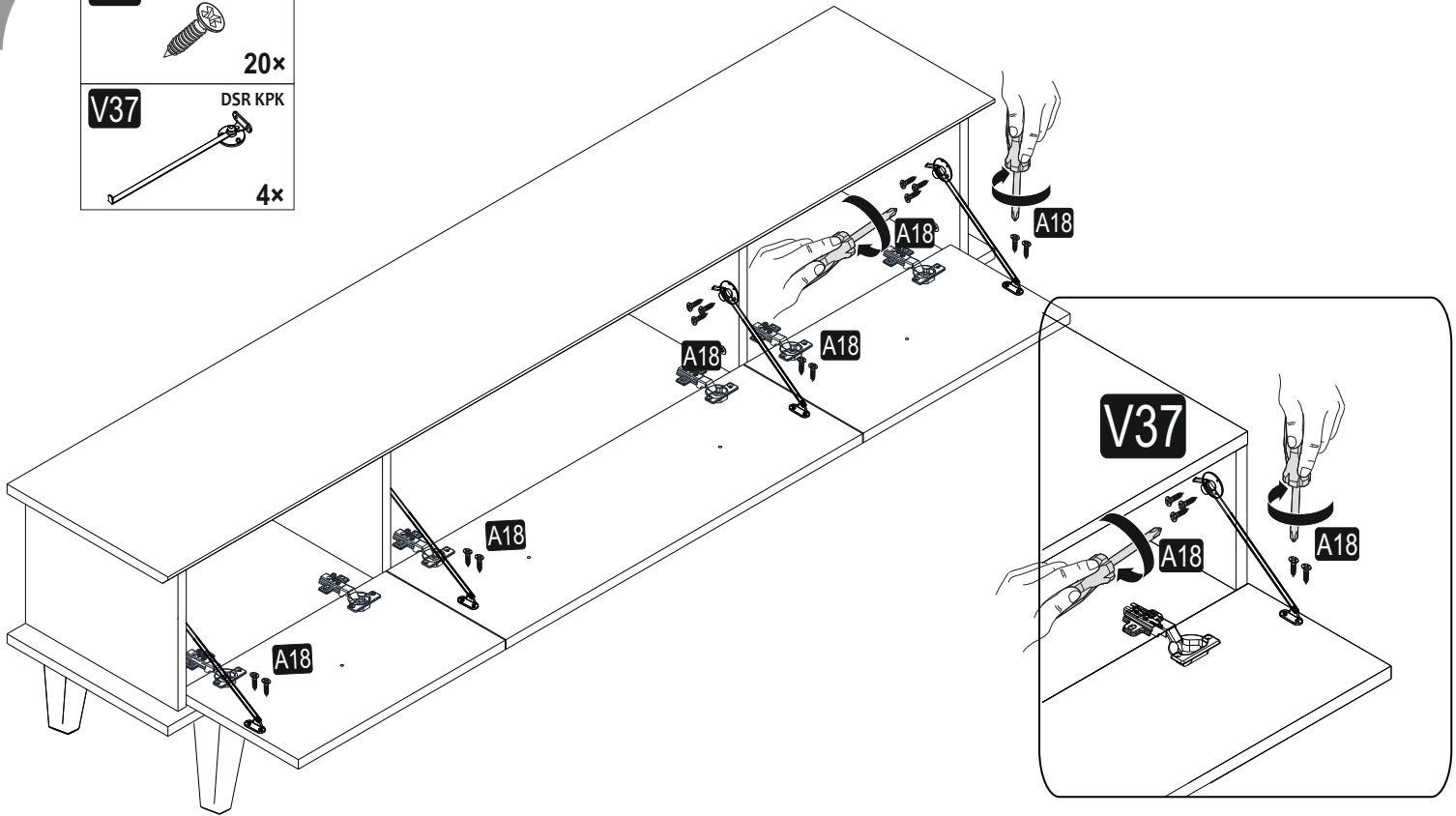
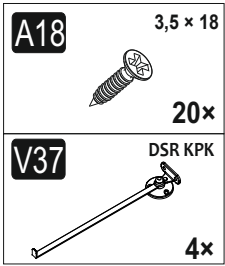

8

